

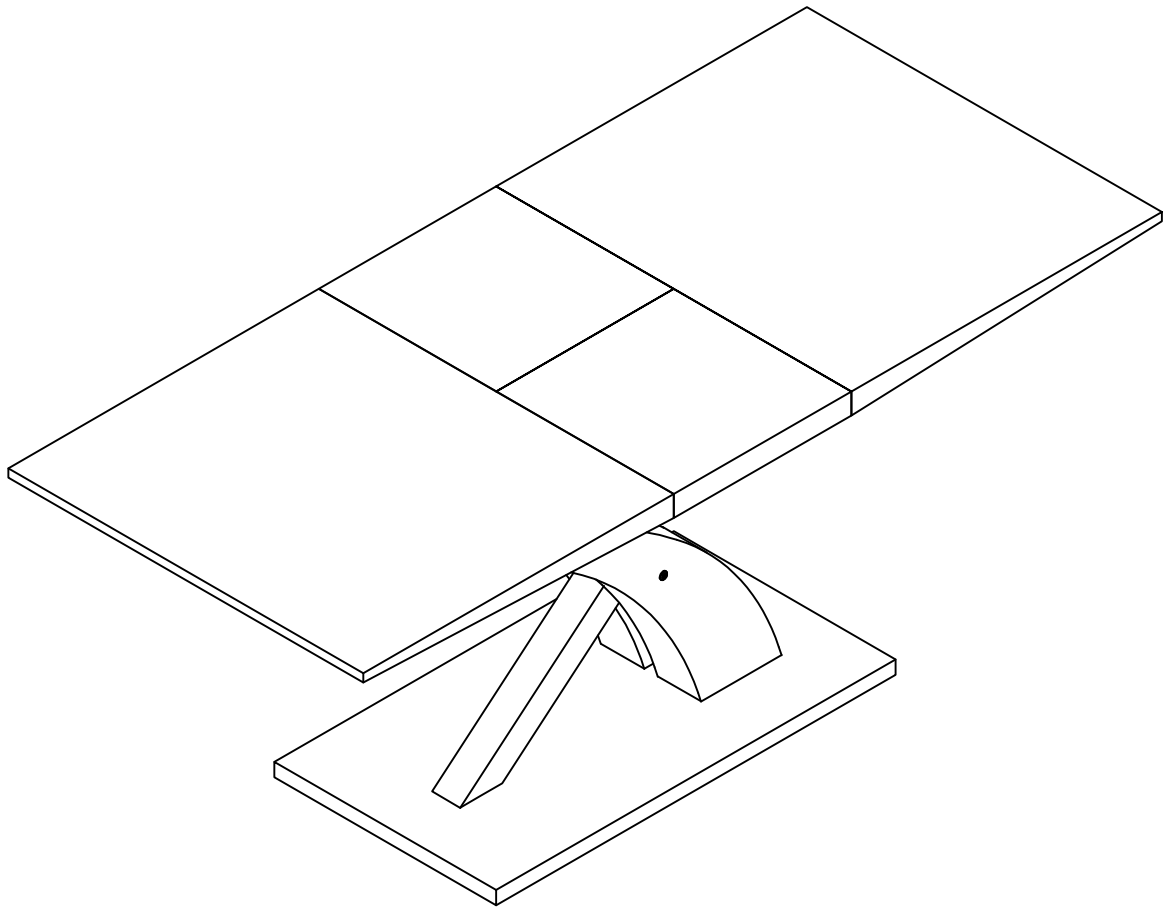

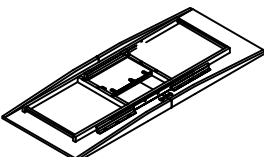









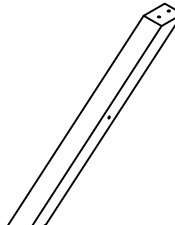
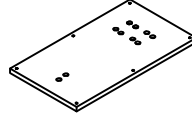

ASSEMBLY INSTRUCTION

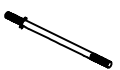
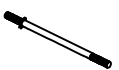
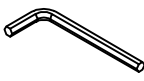

 <p>① x1</p>		 <p>② x2</p>		 <p>③ x1</p>		 <p>④ x1</p>		 <p>⑤ x1</p>		 <p>⑥ x1</p>		 <p>⑦ x1</p>	
<p>A (M6x16mm) x2</p> 		<p>B (M8) x4</p> 		<p>C $\phi 8 \times 22 \text{mm}$ x22</p> 		<p>D (M8) x22</p> 		<p>E (M4) x1</p> 		<p>F (M8x35mm) x18</p> 		<p>G (M8) x2</p> 	
<p>H (M8x140mm) x4</p> 		<p>I (M8x285mm) x1</p> 		<p>J (M5) x1</p> 		<p>K (M6x15mm) x6</p> 		<p>L x2</p> 		<p>M (M8) x1</p> 		<p>1/5</p>	

1

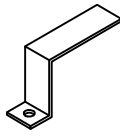
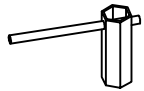
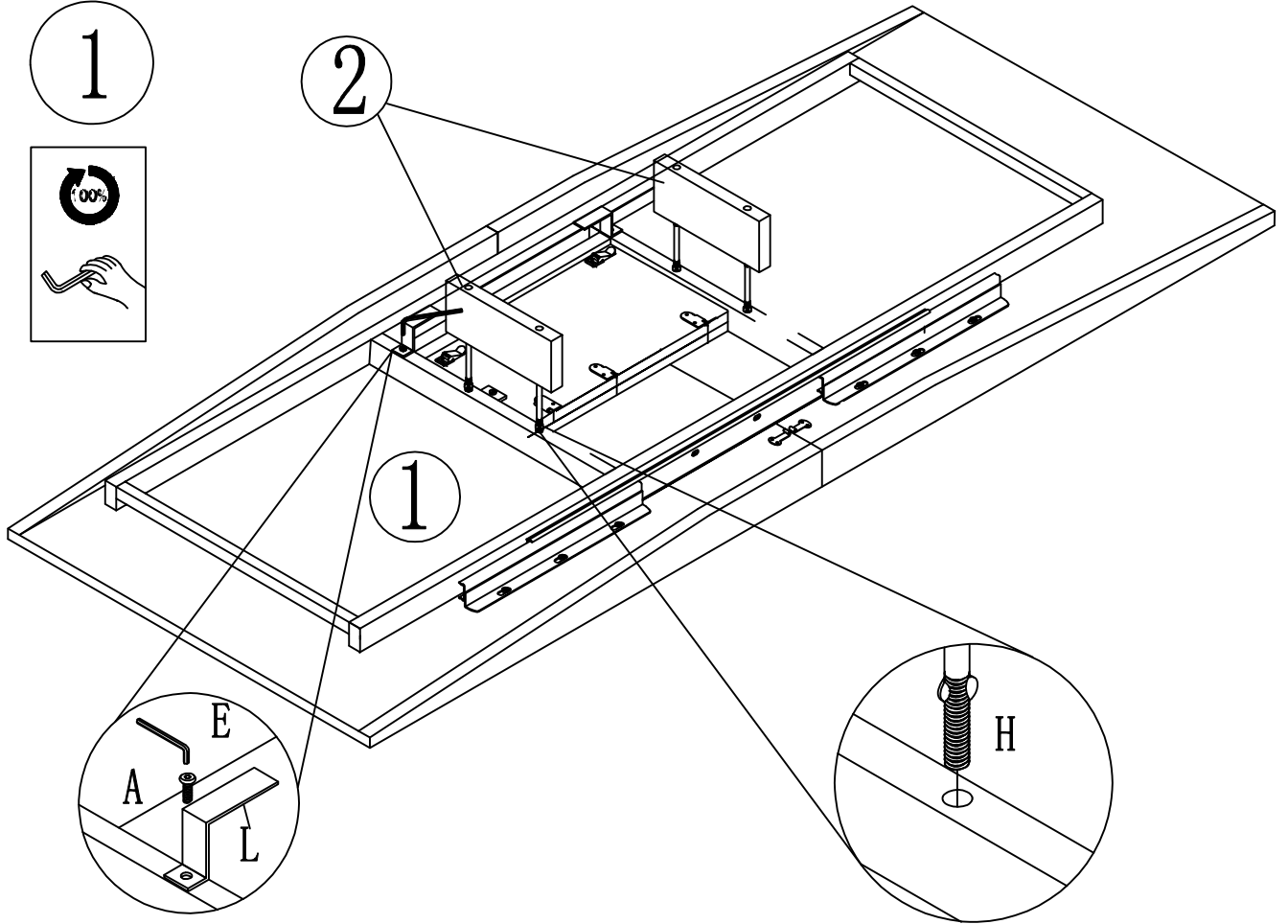
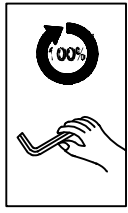

2

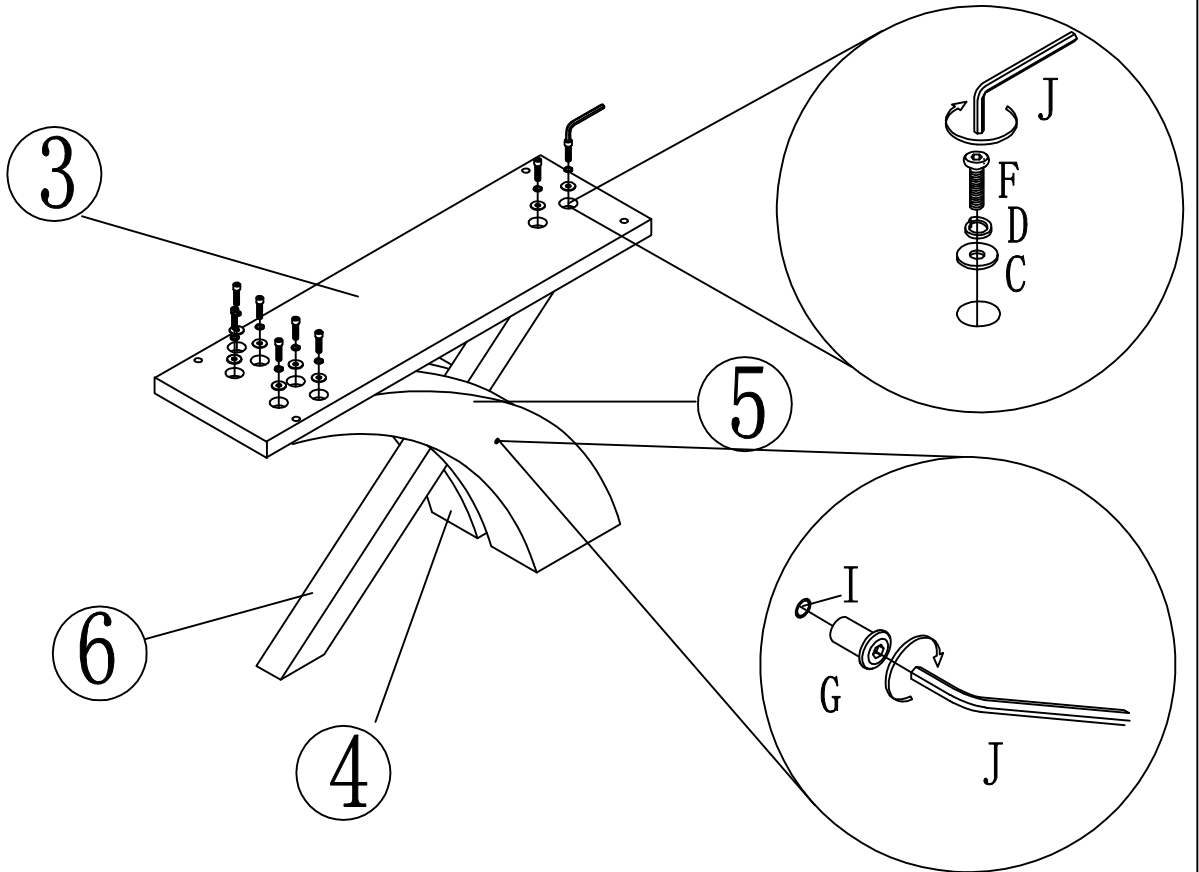
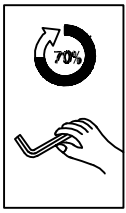

3

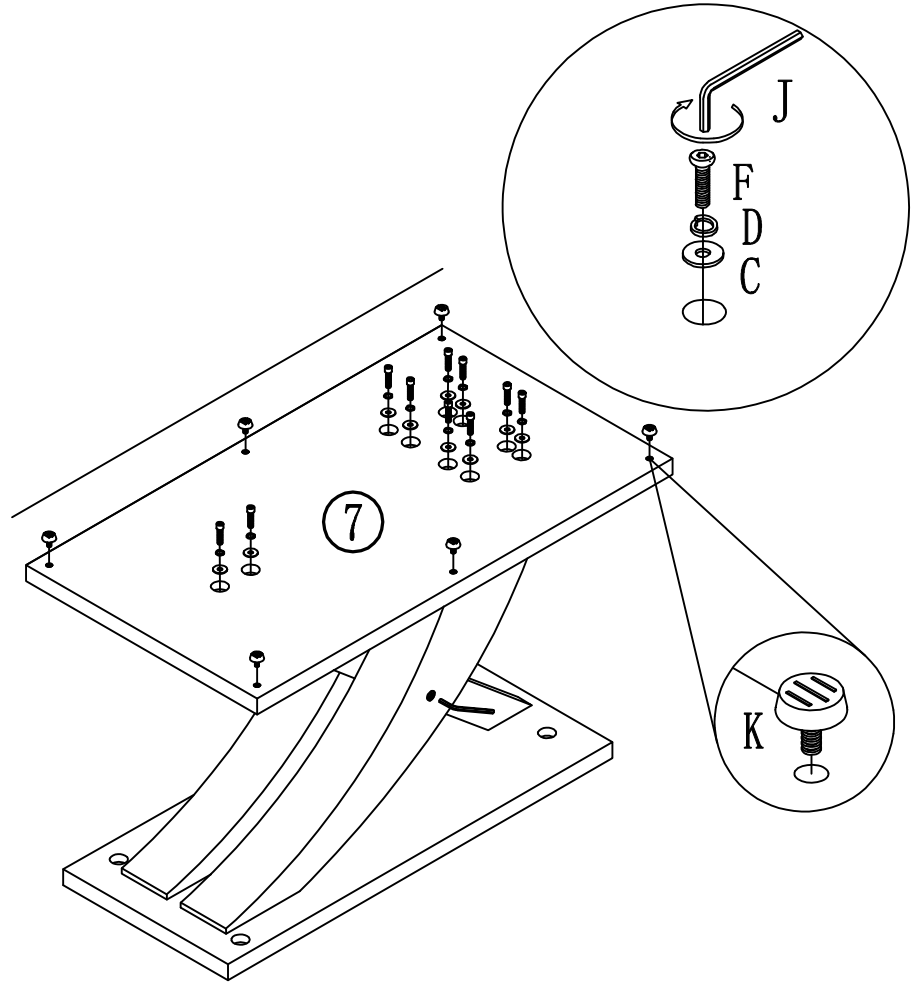
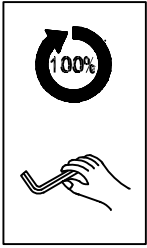

4

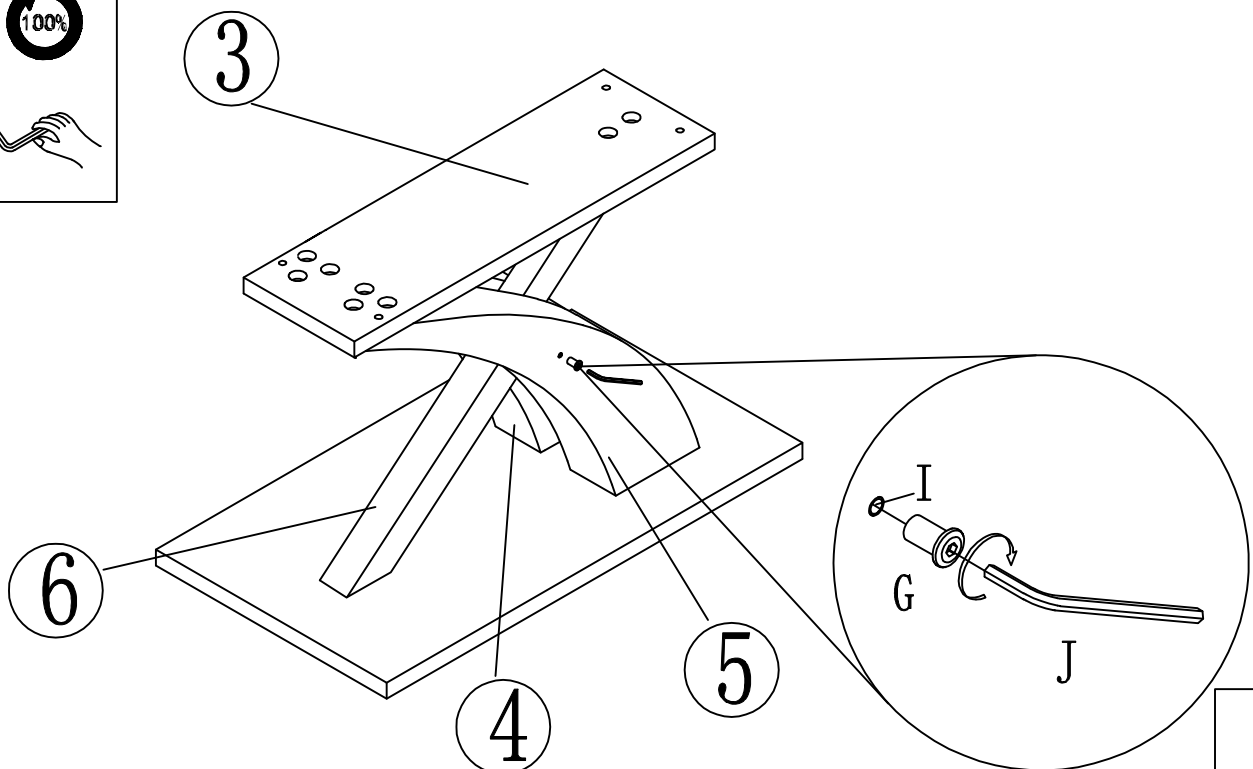
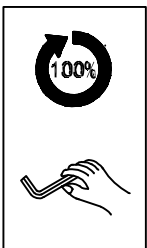

5

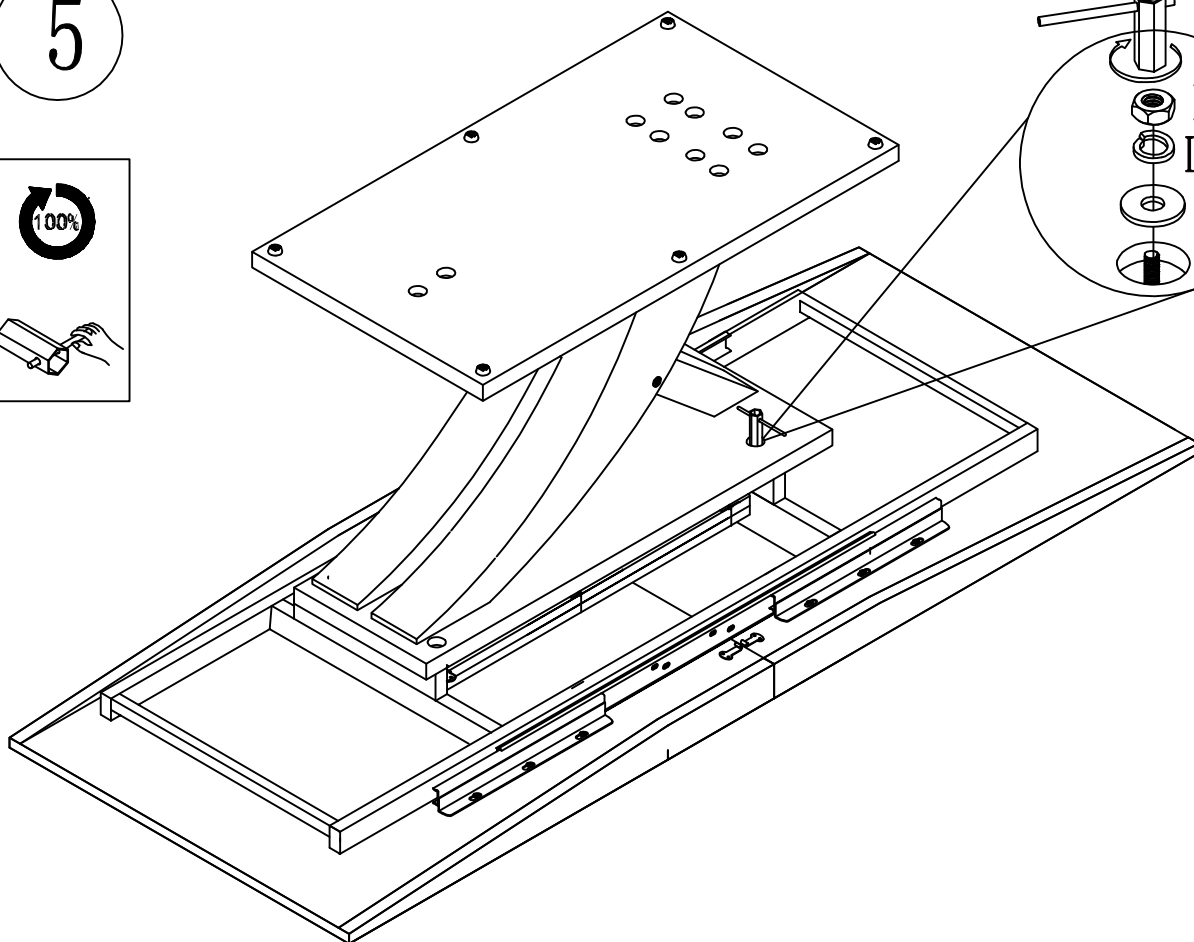
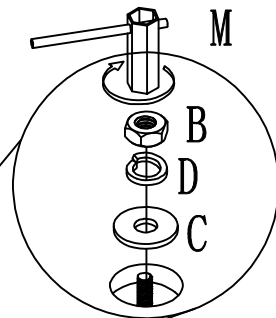
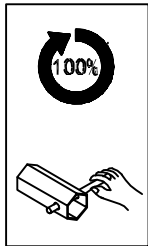

6

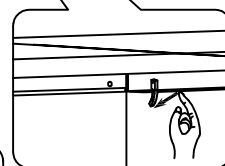
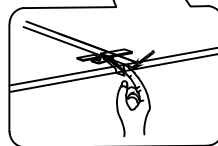
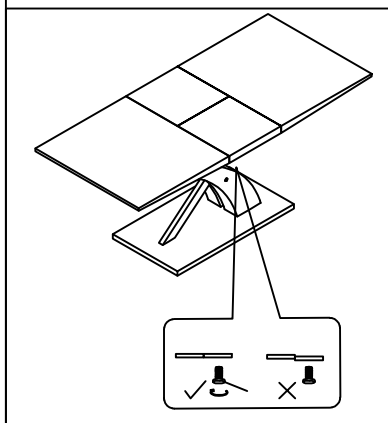
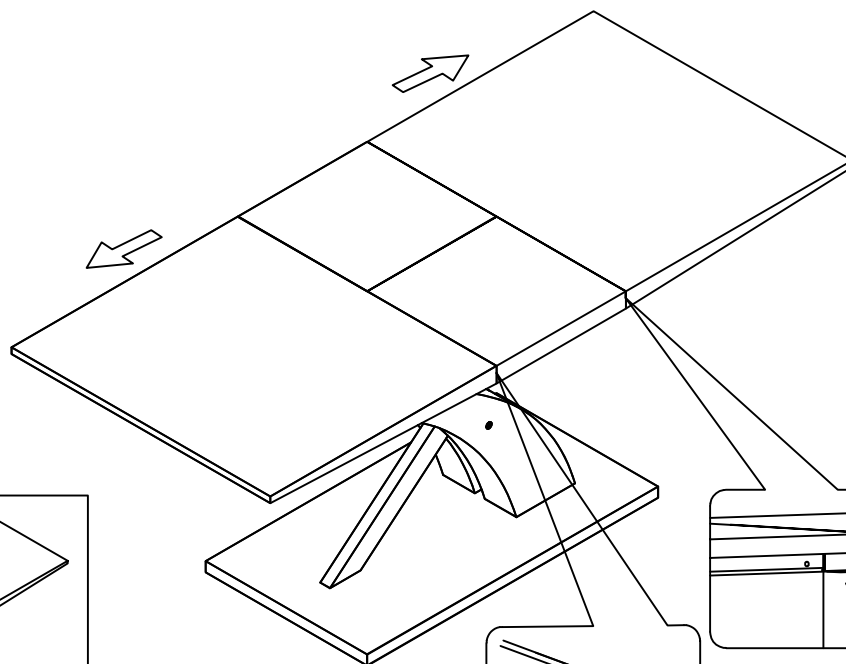

7

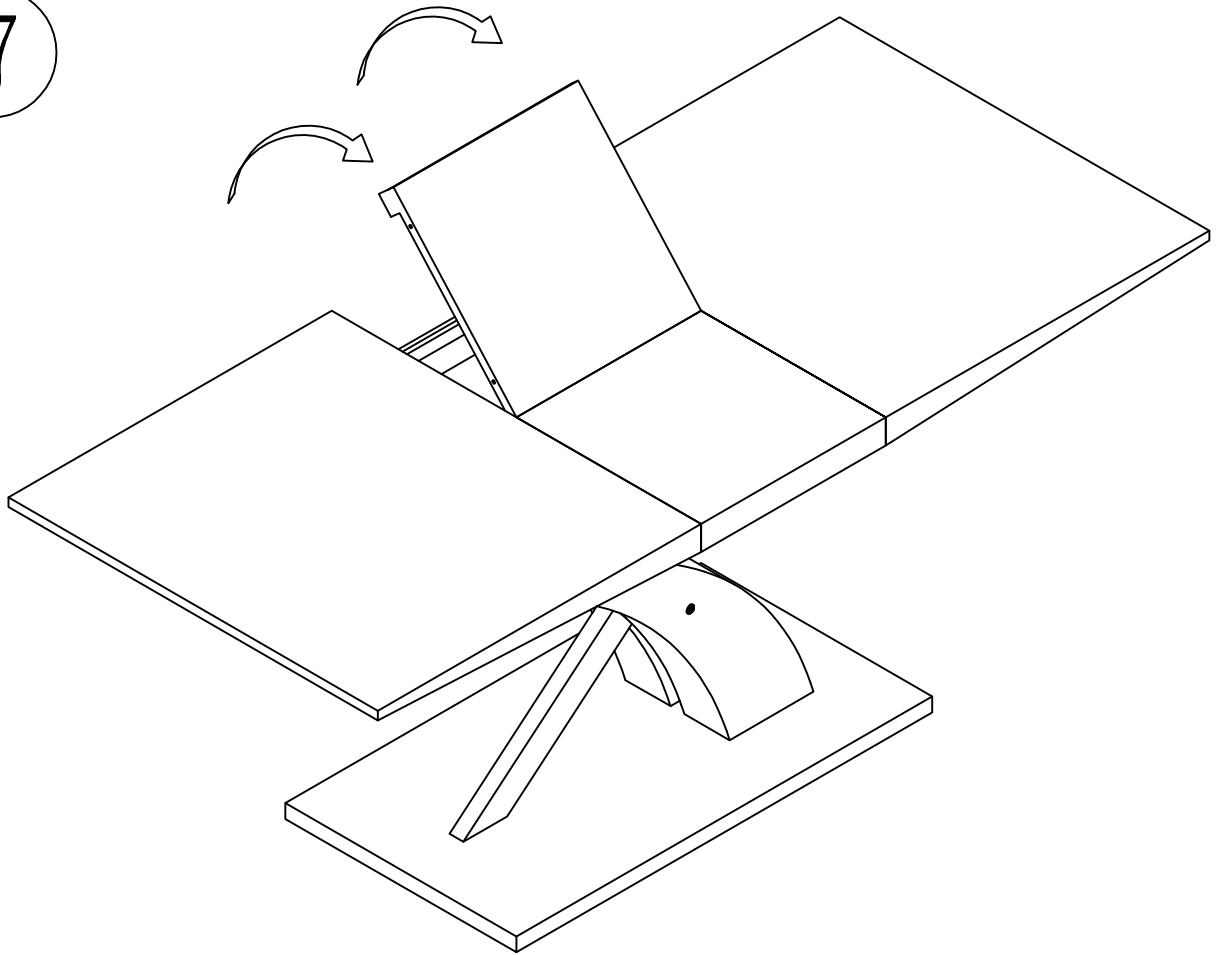

8

